



# Zapp Plus™

## *Users Guide*

Version 20231107 • Part #1620



**sunstone®**

The Micro Welder Experts



**ATTENTION: Read the Safety Guide before operating this welder!**  
**Operator assumes all liability.**



### **LIMITATION OF LIABILITY**

IN NO EVENT, UNDER ANY CAUSE OF ACTION OF THEORY OF LIABILITY, SHALL SUNSTONE ENGINEERING LLC, ITS DISTRIBUTORS, OR SUPPLIERS BE LIABLE TO YOU OR ANY THIRD PARTY FOR ANY INDIRECT, INCIDENTAL, CONSEQUENTIAL, SPECIAL, EXEMPLARY OR PUNITIVE DAMAGES, OF ANY NATURE WHATSOEVER, ARISING OUT OF THE USE OF OR INABILITY TO USE ANY SUNSTONE ENGINEERING LLC PRODUCT, INCLUDING, WITHOUT LIMITATION, PROPERTY DAMAGE, LOSS OF VALUE OF THE SUNSTONE ENGINEERING LLC PRODUCT OR ANY THIRD PARTY PRODUCTS THAT ARE USED IN OR WITH THE SUNSTONE ENGINEERING LLC PRODUCT, OR LOSS OF USE OF THE SUNSTONE ENGINEERING LLC PRODUCT OR ANY THIRD PARTY PRODUCTS THAT ARE USED IN OR WITH THE SUNSTONE ENGINEERING LLC PRODUCT, EVEN IF SUNSTONE ENGINEERING LLC HAS BEEN ADVISED OF THE POSSIBILITY OF SUCH DAMAGES. WITHOUT LIMITING THE FOREGOING, YOU UNDERSTAND AND AGREE THAT SUNSTONE ENGINEERING LLC HAS NO LIABILITY FOR ANY DAMAGE OR DESTRUCTION TO ANY PROPERTY. NOTWITHSTANDING ANY DAMAGES THAT YOU MIGHT INCUR FOR ANY REASON WHATSOEVER (INCLUDING, WITHOUT LIMITATION, ALL DAMAGES REFERENCED HEREIN AND ALL DIRECT OR GENERAL DAMAGES IN CONTRACT, TORT (INCLUDING NEGLIGENCE) OR OTHERWISE), THE ENTIRE AGGREGATE LIABILITY OF SUNSTONE ENGINEERING LLC AND ANY OF ITS DISTRIBUTORS AND/OR SUPPLIERS SHALL BE LIMITED TO THE AMOUNT ACTUALLY PAID BY YOU FOR THE SUNSTONE ENGINEERING LLC PRODUCT GIVING RISE TO LIABILITY. SOME STATES AND/OR JURISDICTIONS DO NOT ALLOW THE EXCLUSION OR LIMITATION OF INCIDENTAL OR CONSEQUENTIAL DAMAGES, SO THE ABOVE LIMITATIONS OR EXCLUSIONS MAY NOT APPLY TO YOU. THE LIMITATIONS OF LIABILITY SET FORTH ABOVE SHALL APPLY TO THE MAXIMUM EXTENT PERMITTED UNDER APPLICABLE LAW.

REVISION	DATE	VERSION NO.	DESCRIPTION OF CHANGES
1	11/2023	20231107	First Edition

# Contents

Welder Setup & Assembly .....	1
Electrode Setup .....	2
How to Use the Dial.....	3
How to Make a Weld .....	4
Recommended Weld Settings .....	6
Electrode Care & Shield Gas Setup.....	7
Microscope Tips .....	10
Appendix A .....	11
How to Connect the Basic Cables With Auto Darkening Lens.....	11
How to Place the Welding Stylus .....	12
Appendix B .....	13
Microscope Arm Mounting Options .....	13
How to Adjust Microscope Focus .....	15
How to Place the Welding Stylus .....	16
Welder Specifications .....	15



## Permanent Jewelry Training Video

*Watch this video for permanent jewelry training, setup recommendations, time-saving tips and tricks, and more!*



## Pulse Arc Welding Workbook and Safety Guide

*Download this document to access advanced welding techniques and safety information.*



## Welder Setup & Assembly

### What is in the Box

- (1) Zapp Plus Welder/Power Supply and Stylus Hand Piece
- (1) Zapp Plus Welder Power Cord (2 pieces)
- (1) Alligator Clip
- (1) Precision Grounding Clip
- (1) Shielding Gas Hose
- (1) Electrode Vial (three 1.0 mm Electrodes)
- (1) Metal sample card
- (1) Pair of shaded welding glasses

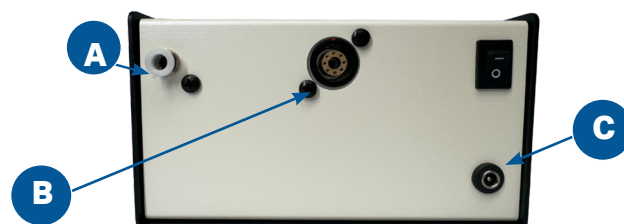

Figure 1.1. The back panel of the Zapp Plus. Argon Gas Port (A). Stylus Port (B). Power Port (C).



Figure 1.2. The back panel of the Zapp Plus. Grounding Port (D). Shutter Port (E).

## How to Connect the Basic Cables

### WITHOUT LENS/MICROSCOPE

The Zapp Plus does not require the use of any lens or microscope. Always wear proper eye protection when you are using the Zapp Plus. The provided welding glasses will protect your eyes from damage due to the arc flash.

- Remove welder and accessories from the box and place on a flat workspace.
- Plug the male end of the power cable into the AC Power port (C) on the back of the power supply. Then connect the female end into an AC power supply. **The Zapp Plus Plus has an internal switching power supply that can accept both 120 and 240VAC.**
- Insert the 1/4" gas tube firmly into the Gas port (A) on the back of the welder. It may wiggle when connected, but should not come out if pulled on.
- Connect the alligator clip to the grounding port (D) on the front panel.
- Connect the stylus to the back of the welder (B).

## Electrode Setup

The Zapp Plus comes standard with a 1.0mm electrode collet and three (3) 1.0mm electrodes. The 1.0mm electrodes are a good multipurpose electrode for most welding applications. Available separately, Sunstone offers 0.5mm electrodes.



Figure 2.1. To install the electrode, first remove the Styling Shaft (A) from the Styling Hull (E) by pulling them apart.



Figure 2.2. Use the guide on the side of the Styling Hull (E) for proper Electrode (D) positioning.



Figure 2.3. Electrodes should protrude past the styling hull 1/8 to 1/4 inch (3.175 to 6.35mm).

## Install the Tungsten Electrode Onto the Welding Stylus

Refer to the Stylus Components Chart (Figure 2.4) to install the tungsten electrode (D).

- Remove the Styling Hull (E) by pulling it away from the Styling Shaft (A). See Figure 2.1.
- Loosen the Collet Cap (C) by twisting it counter-clockwise.

*The welder accommodates 0.5mm and 1.0mm electrodes. The electrode stylus will be shipped with the 1.0mm electrode collet installed.*

- Insert a 1.0mm electrode (D) into the Collet (B).

*Helpful Tip: There is a machined groove on the side of the Styling Hull (E) that helps measure the electrode length. Place the end of the Styling Hull (E) against the Collet Cap (C), then make sure the Electrode (D) extends as indicated. See Figure 2.2.*

- There should be between 0.6 - 0.7 inch (1.5 – 2cm) of the Electrode (D) protruding from the Styling Shaft (A). This will allow the Electrode enough room to stick out from the Styling Shaft once the Styling Hull (E) is placed back on the Styling Shaft.
- Lock the Electrode (D) into place by hand tightening the Collet Cap (C) in a clockwise direction.
- Replace the Styling Hull (E) by pushing it in until you feel it snap back into place. The Electrode (D) should protrude from the Styling Hull (E) by 1/8 – 1/4 inch (3.175 – 6.35mm) after the Styling Hull is snapped back into place. See Figure 2.3.

### Stylus Components

Figure 2.4.



Stylus Shaft A



Collet B



Collet Cap C



Electrode D



Stylus Hull E

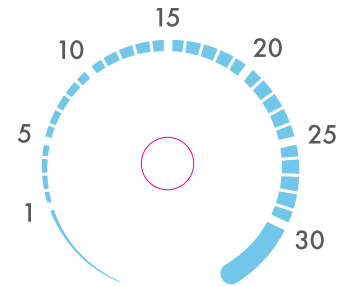
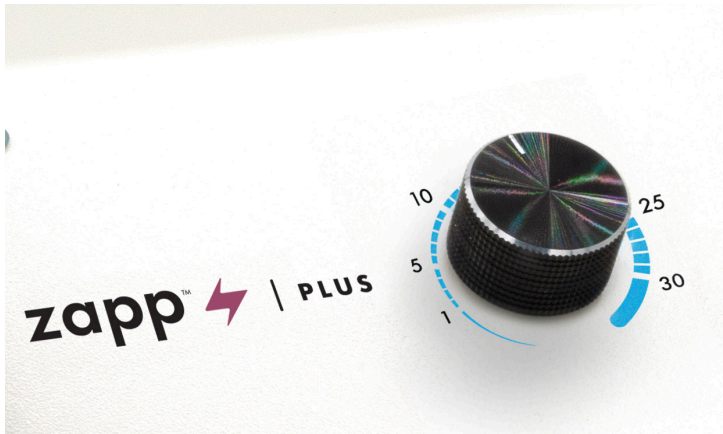

Figure 3.1. The dial and its settings.

## How To Use the Dial

---

The Zapp Plus dial is very user friendly. Users have access to every welding parameter with one easy-to-use dial.

### Weld Energy Level

The Zapp Plus has weld energy range of 1 to 30 Joules (or Ws), which is selected in one joule increments. The larger the number the more energy released through the electrode and, generally speaking, the larger the weld spot.

### Weld On/Off

When the Zapp Plus is initially powered on it is ready to weld. A small green light in the upper left corner, near the knob, will illuminate when the Zapp Plus is ready to weld. Power the unit off if a non-weld state is desired.

### The Dial

As you twist the dial to the right, the Weld Energy Level will increase 1 Joule. 3 = 3 Joule, 4 = 4 Joules, etc. Pointing the arrow on the dial directly at the number will give the most accurate power reading.

### Light Blink

When the small LED light blinks, the Zapp Plus is changing energy. As the knob is turned up or down this blink indicates a change in weld setting.

If you've never used the Zapp Plus or other Orion pulse arc welder, you should practice first on the provided welding plate. After careful setup and familiarization of how the welder operates, follow these instructions using the welding plate.



## How To Make a Weld

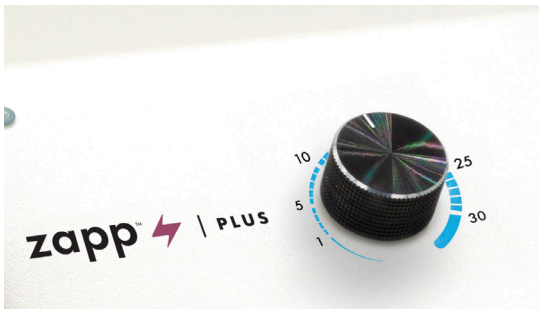

Figure 4.1 Set the Weld Energy Level to 3 J energy.



Figure 4.2 Attach the alligator clip to the welding plate. With proper eye protection, hold the welding plate with both hands and lightly touch the electrode to the welding plate. When the electrode contacts the welding plate, the welder will release energy and create a weld.

- Turn the welder on. With the welder on, **energy will only be released when the electrode touches the welding plate AND the alligator clip is attached to the welding plate (or any workpiece)**. Don't worry about the alligator clip yet.
- Make sure your eyes are protected by properly using the darkening lens or microscope. Never operate the welder without eye protection.
  - If you are using an Auto Darkening Lens (ADL) with the Zapp Plus, refer to Appendix A before proceeding.
  - If you are using a swing arm microscope or the PJ Scope, refer to Appendix B before proceeding.
  - If you don't have an Auto Darkening Lens (ADL), microscope, or PJ Scope, ensure that you are using #5 shaded welding glasses.
- Attach the alligator clip to the Stainless Steel Weld Plate as shown in Figure 4.2.
- Rest your arms on the table or workbench, holding the metal plate with both hands.
- Make sure you have a clear view of the metal plate.
- The Stainless Steel Weld Plate is organized into rows. For this exercise, lightly touch the welding plate (or workpiece) to the electrode in the first minimum column. When the electrode makes contact with the welding plate, the welder will release energy and a weld will occur.

*Note: Sloped, Sustained, and Negative Rows are not*



*applicable to the Zapp Plus, so ignore the labels and focus on the row labeled "None". Create lower-powered practice welds on the left and higher powered welds as you move right (maximizing at 30J).*

*Tip: When the electrode touches the workpiece, don't back away from the electrode until after the weld is completed. The Zapp Plus will automatically retract the electrode away from the workpiece by a few millimeters when the weld occurs. This retraction assists in forming a more desirable weld spot. If you move the workpiece away from the electrode just before or during the weld, the weld will not occur.*

- Adjust the Weld Energy Level from 1 to 2J using the dial. Then touch the electrode to the second minimum column.
- Next, adjust the Weld Energy Level from 3 to 4J using the knob. Then touch the electrode to the second minimum column. You will see a difference between the 3J weld and the 4J weld. The spot size will be larger and the weld will be deeper.
- Repeat the process of increasing the energy level and then touching the plate in the next box. And then repeat again until you've placed a weld in every box. Eventually, you should reach the maximum amount of power (30J).

## What To Do If The Knob Comes Off

---

Spin the potentiometer as far as it can counterclockwise. Push the knob onto the potentiometer with the marking indicator pointing at the left marking on the sticker.

## Weld Settings for Chain

---

Below are energy settings for Sunstone's chains.

### Aria

- Yellow Gold Filled (3J)
- Sterling Silver (3J)

### Aspen

- Rose Gold Filled (3J)
- Yellow Gold Filled (5J)
- Sterling Silver (5J)

### Brittany

- Rose Gold Filled (6J)
- Yellow Gold Filled (6J)
- Sterling Silver (5J)

### Bryce

- Rose Gold Filled (6J)
- Yellow Gold Filled (3J)
- Sterling Silver (3J)

### Charlie

- Yellow Gold Filled (4J)
- 14k Yellow Gold (4J)
- Sterling Silver (4J)

### Chloe

- Rose Gold Filled (4J)
- Yellow Gold Filled (4J)
- 14k White Gold (4J)
- 14k Yellow Gold (4J)
- Sterling Silver (4J)

### Ella

- Rose Gold Filled (5J)
- Yellow Gold Filled (5J)
- Sterling Silver (5J)

### Paisley

- Yellow Gold Filled (4J)
- Sterling Silver (3J)

### Robyn

- Rose Gold Filled (4J)
- Yellow Gold Filled (4J)
- 14k Yellow Gold (4J)

### Sarah

- Yellow Gold Filled (4J)
- 14k Yellow Gold (4J)
- Sterling Silver (4J)

### Shaylee

- Rose Gold Filled (7J)
- Yellow Gold Filled (7J)
- Sterling Silver (6J)



### Need more Chain?

Scan the QR Code and find all of our Sunstone Chains!

# Electrode Care & Shield Gas Set Up

## Electrode Care

### WORKPIECE ELECTRODE PRESSURE

Touch the workpiece to the electrode with very light pressure. Too much pressure will cause the workpiece to stick to the electrode and cause the electrode to become contaminated (workpiece material on the electrode). Sunstone recommends cleaning or changing the electrode when it sticks to the workpiece. A clean, sharp electrode will give the best results when welding permanent jewelry.

### WHEN TO SHARPEN THE ELECTRODE

The majority of applications are best accomplished using a sharp electrode tip. A sharp tip improves arc initiation and helps focus the arc properly. It is recommended that you pay close attention to the electrode condition. An electrode that appears to be dark colored or covered with material from previous welds can lead to inconsistent welding and poor ignition of the weld arc. When this occurs, simply sharpen the electrode with the included diamond disk. The diamond disk can be attached to a rotary tool. Follow these steps for sharpening the electrode:

- Completely remove the electrode from the stylus.
- Pinch the electrode between the thumb and index and/or middle finger with the shaft going perpendicular to the fingers. See Figure 7.2.
- Power on the rotary tool then hold it with the opposite hand.
- Place the electrode tip on the diamond disc so the grit of the disk is moving parallel with the electrode shaft and moving towards the tip.

Stylus Hull



Example of a Sharp Electrode Tip

Figure 7.1.



Figure 7.2. A sharp electrode tip improves arc initiation and results in a better overall weld.



Figure 7.3. Use a rotary tool to sharpen the electrode.



Trade your old rotary tool for the Pilot, the electrode sharpener that cleans and sharpens your electrode in seconds! Visit [www.sunstonewelders.com](http://www.sunstonewelders.com) or call or text +1 801-658-0015 to learn more.



Need argon gas? Sunstone will ship a right-sized tank to your doorstep. No more adventurous trips to the gas store! Call Sunstone for immediate delivery: +1 801-658-0015 or scan the QR code above.



- See Figure 7.3. Sharpening the electrode in a way other than explained here will affect the quality of the weld.
- Set the electrode on the diamond disk at a 15-degree angle and begin to spin the electrode with the thumb and middle finger. **Tip: A helpful way to get a sharp electrode is to push down on the electrode with your index finger while twisting the electrode with the thumb and middle finger. See Figure 7.2.**
- Once the electrode is sharp and clean, turn off the rotary tool and insert the electrode back into the stylus as explained above.



For Pop-Ups and other remot locations, try the new Argon Mini! Call Sunstone for immediate delivery: +1 801-658-0015 or scan the QR code above.



## Shield Gas Setup

During the pulse arc welding process high temperature plasma quickly melts metal into a molten pool. As the weld is performed, a small amount of shielding gas is released through the weld stylus to prevent oxygen from entering the molten pool. After the weld has occurred the protective gas turns off.

If oxygen from the air enters this molten pool, the result is a metal oxide that is brittle, porous, and burnt-looking. Protective shielding gas is used, such as 99.996% pure argon (Argon 4.6), to prevent these effects.

## PRESSURIZED GAS SAFETY

There are several important rules that should be followed when using a compressed shielding gas such as argon:

**Always secure the pressurized gas tank to a fixed**

### Purchase premium argon gas from Sunstone.

Call +1 801-658-0015

visit [www.sunstonewelders.com/gas](http://www.sunstonewelders.com/gas).

- Delivered directly to your door!
- Right-sized tank fits almost anywhere!
- Premium argon gas for your Zapp Plus!

**location** (such as a sturdy table leg). If the pressurized gas cylinder were to tip and become damaged there is possibility that the tank could become a projectile, expelling the high-pressure shielding gas as propellant.

**Always turn off the shielding gas at the main valve when finished.** This will help your shielding gas supply last longer in case there is a small leak in the tubing. This is also a good safety practice. If the tube becomes dislodged shielding gas could fill the room and displace oxygen, which can lead to suffocation. Argon is heavier than air and will fill the room from the bottom upward. If you experience a large shielding gas leak, open all of the doors and windows in the room.

## SHIELDING GAS TANK AND REGULATOR SETUP

*The following instructions are specific for a Sunstone argon regulator. Other regulators may operate differently. Consult instructions that may have come with other regulators.*



- Ensure that your shielding gas tank is securely fastened to a stationary point near the welding area.
- Turn the argon regulator dial (not to be confused with the main argon tank valve) COUNTERCLOCKWISE (closed) until it is fully backed out, meaning the dial becomes loose, to prevent over-pressurization of the line.
- Screw the gas regulator onto the shielding gas tank and tighten fully using a wrench.
- If not already done, insert one end of the included 1/4" OD gas tubing into the gas port on the back of the power supply. Tug gently on the tube to verify a tight fit.
- Connect the other end of the gas tubing to the gas regulator.
- Open the gas tank at the main valve slowly. The dials attached to the regulator should respond as the valve is opened. The primary dial measures and shows pressure inside the tank; the secondary dial, which measures pressure in the hose, should remain at zero (when the regulator dial is fully backed out).
- Slowly turn the regulator dial CLOCKWISE until the secondary dial on the left shows gas pressure between 7-10 liters per second.



*Scan this QR Code to see a tutorial of how to set up your Argon Tank.*

## Appendix A

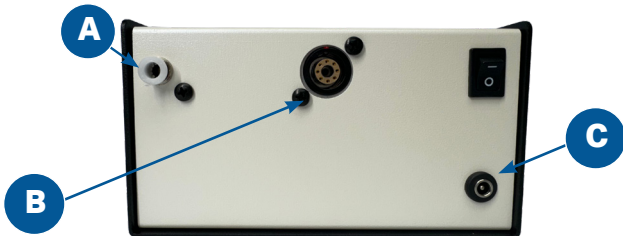

Figure 10.1. The back panel of the Zapp Plus. Argon Gas Port (A). Stylus Port (B). Power Port (C).

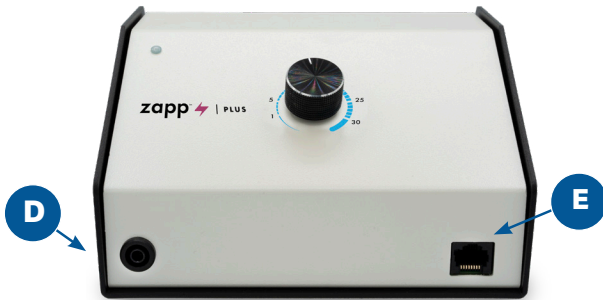

Figure 10.2. The back panel of the Zapp Plus. Grounding Port (D). Shutter Port (E).

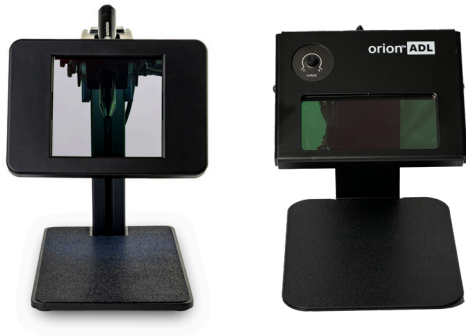

Figure 10.3. Upgraded Auto Darkening Lens (Left) and Regular Auto Darkening Lens (Right).

### How to Connect the Basic Cables With Auto Darkening Lens

The Zapp Plus cable connections vary. **If you purchased the darkening lens or the microscope, cabling needs change slightly.** The darkening lens or microscope will automatically darken when the weld takes place, which allows the operator to have a view of the work piece and remain protected from the flash during the welding process. Reference Figure 10.1 and follow these instructions for easy setup:

- Remove the welder and Darkening Lens System from the box and place them on a flat work-space.
- Plug the female end of the power cable into the AC Power port (C) on the back of the power supply. Then connect the male end into an AC power supply. **The Zapp Plus has an internal switching power supply that can accept both 120 and 240VAC.**
- Insert the 1/4" gas tube firmly into the Gas port (A) on the back of the welder. It may wiggle when connected, but should not come out if pulled on.
- Insert the RJ45 Darkening Lens cable (from the back of the Darkening Lens System or "ADL") into the Shutter port (E) on the front of the welder. If using a microscope, see page 5 for instructions.
- *Note: Basic ADL is hard wired into the auto-darkening lens. Upgraded ADL requires 2 connections: 1) Shutter Port on the welder, and 2) RJ45 Port on back of ADL.*

- Connect the alligator clip to the grounding port (D) on the front panel.
- Connect the stylus to the back of the welder (B).
- The basic Auto Darkening Lens darkness can be adjusted by turning the shade dial above the darkening lens screen. Turn clockwise for a lighter shade and counter-clockwise for darker shade.

## How to Place the Welding Stylus

- Insert the Welding Stylus into the holder located behind the screen. See Figure 11.1 (Right).
- Adjust the stylus holder to approximately a 45-degree angle as shown in Figure 11.1 (the stylus should be angled down).
- Connect the Stylus Cord to the back of the Zapp Plus to the stylus port as seen in Figure 10.1.



*Figure 11.1. Stylus mounting for the Auto Darkening Lens System.*

## Mounting Zapp Plus Stylus in Upgraded Darkening Lens:

- Remove gray spacer (See Figure 11.2) from stylus holder. This is lightly glued into place to not come loose during operation with the Orion Stylus. The spacer is not required when using the Zapp Plus stylus. One end of the spacer has a lip or flange to prevent the spacer from going too far into the hole. With a flat head screwdriver or flat object lightly tap the spacer inside the stylus holder until the spacer slides out the end of the holder.
- Connect Included shutter cable into the RJ45 port I both the welder and the ADL.
- Place Zapp Plus Stylus in stylus holder and secure using thumb screw.
- Adjust stylus to desired position inside of viewing area of ADL.



## Appendix B

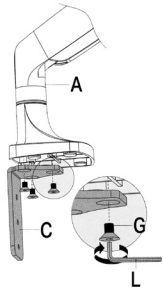

Figure 12.1. Attach Angled Bracket (C) to Microscope Arm Assembly (A).

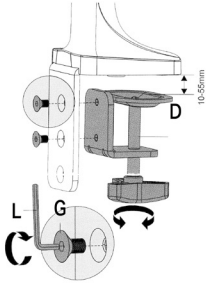

Figure 12.2. Attach Clamp Mechanism (D) to Angled Bracket (C).

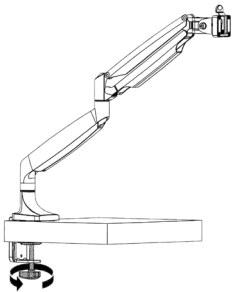

Figure 12.3.

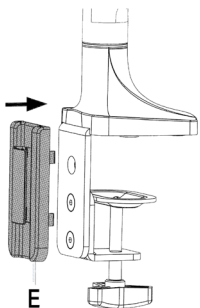

Figure 12.4. Place the cable cover onto the angled bracket.

### Microscope Arm Mounting Options

If you purchased the Zapp Plus with an arm-mounted microscope, carefully follow these instructions.

#### Mounting Option 1 - Clamp to Table

This option is best for tables with accessible edges and for mounting without drilling holes in the table.

#### Hardware required from Box 2:

- (1) Angled Bracket (C)
  - (1) Sunstone Microscope Arm Assembly (A)
  - (1) Clamp Mechanism (D)
  - (5) Flat Head Hex Screws (G)
- Lay the arm assembly down on a flat surface.
  - As shown in Figure 12.1, attach the Angled Bracket (C) to the bottom of the Microscope Arm Assembly using three (3) of the included flat head hex screws (G) using a 4mm (5/16") Allen wrench (L).
  - Attach the Clamp Mechanism (D) to the Angled Bracket (C) using two (2) of the included flat head hex screws. See Figure 12.2. For thicker tables, attach the clamp mechanism (D) to the two lower holes in the Angled Bracket (C).
  - Adjust the knob on the Clamp Mechanism (D) until the gap is sufficient for the thickness of your tabletop.
  - Lift the Microscope Arm Assembly (A) up, slide the arm onto the table as shown in Figure 12.3.
  - Lock the arm into place by turning the knob on the Clamp Mechanism (D) until the clamp is pressing firmly against the bottom of the table.

- A plastic cable guide cover (E) can be clipped on over the angled bracket if desired. See Figure 12.4.

## Mounting Option 2 - Bolt through Table

Mounting Option 2 is best for tables without accessible edges. Hardware required from Box 2:

- (1) Flat Mounting Plate (H)
- (3) Flat Head Hex Screws (G)
- (1) Long Carriage Bolt (F)
- (1) Flat Pressure Plate (I)
- (1) Adjustment Knob (J)
- As shown in Figure 13.1, using a 4mm (5/32") Allen wrench, unscrew the flat head hex screws (G) holding the Flat Mounting Plate (H) to the arm.
- Run the included 8mm (5/16") Long Carriage Bolt (F) through the included Flat Mounting Plate (H).
- Attach Flat Mounting Plate (H) to the bottom of the arm using (3) flat head hex screws (G).
- Drill a 3/8" (9.5mm) hole through the tabletop.
- Lower the arm so the Long Carriage Bolt (F) goes through the hole in the tabletop. See Figure 13.2.
- Slide the Flat Pressure Plate (I) onto the bolt. Turn the Adjustment knob (J) clockwise to tighten the plate to the underside of the table. See Figure 13.3.

Figure 13.1. Remove the plate from the arm, run the carriage bolt (F) through the mounting plate (H), then re-attach the mounting plate to the arm.

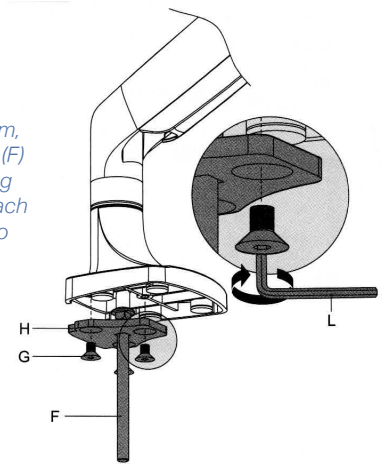

Figure 13.2. Lower the arm so the bolt goes through the hole in the table.

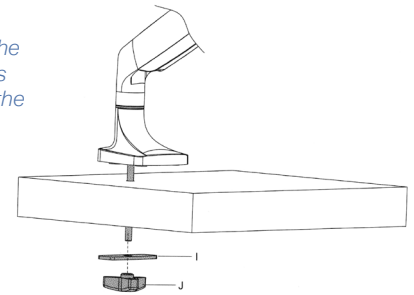
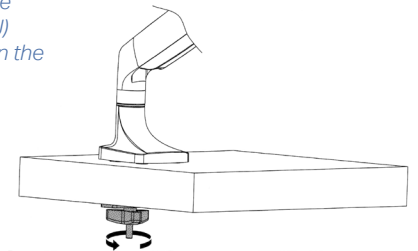

Figure 13.3. Turn the Adjustment knob (J) clockwise to tighten the plate to the table.



## Mounting Option 3 - Screw to Table (vertical surface)

Required hardware from Box 2:

- (1) Angled Mount Bracket (C)
- (3) Flat Head Screws (G)
- (2) Wood Screws (**not included**)

Figure 13.4. Use wood screws (not included) to attach the Angled Mount Bracket (C) to the table.

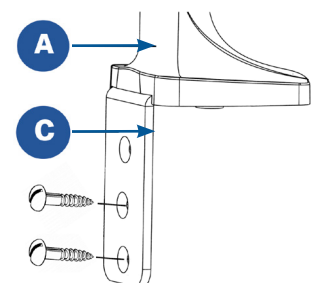



Figure 14.1. Adjust the tension of the Microscope Arm Assembly for more loose or more tight movement.



Figure 14.2. Tubing and other cables can be routed up and through the removable cable guide portion of the arm.

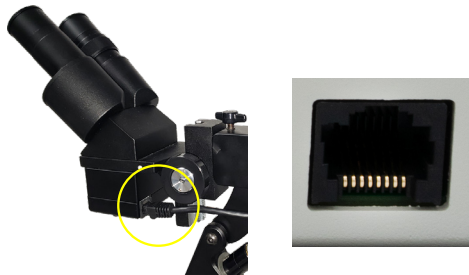

Figure 14.3. After installing the rubber eyepiece covers, use the RJ45 Shutter Cable to connect the welder to the back and bottom of the microscope head. The other end of the cable connects to the port in the front of the Zapp Plus. (See Figure 2.1)



Figure 14.4. PJ Scope.

- Attach the Angled Bracket (C) to the bottom of the Microscope Arm Assembly (A) using three (3) of the included flat head hex screws (G) as shown in Figure 12.1.
- Lift and position the arm assembly onto the table in the desired location.
- Run wood screws through the Mounting Bracket (C) and into a vertical surface of the table, as shown in Figure 13.4.

## ARM TENSION ADJUSTMENT

The spring tension is factory pre-set, but should changes be desired, the tension can be adjusted by turning a hex screw located on the arm joint, as shown in Figure 14.1. Use the included 6mm Allen wrench to make adjustments.

- Turn the hex screw counterclockwise (in the direction of the "+" symbol on the arm) if the arm does not hold the microscope up.
- Turn the hex screw clockwise (in the direction of the "-" symbol) if the arm does not allow the microscope to be lowered easily.

*For cable management, tubes and cables can be routed through a removable guide as shown in Figure 14.2.*

## PJ Scope Set Up

### MICROSCOPE SETUP

- Refer to the setup instructions that shipped with the PJ Scope.
- Plug the included Shutter Cable into the RJ45 port on the microscope (the bottom of the microscope head). See Figure 14.3.
- Plug the other end of the Shutter Cable into the Shutter port on the front of the welder.

*Note: Connecting non-Sunstone products to the RJ45 port on the Zapp Plus may damage the welder and/or the other devices.*

## How to Adjust Microscope Focus

- Twist the knob on the microscope forward and backward to lower and raise the head. This will allow you to focus the microscope on the welding stylus. See Figure 15.1.
- Place your finger under the welding electrode to help judge the correct focus location. Focus the microscope until the texture on the skin of your finger is clearly visible.



Figure 15.1. Turn this knob to adjust microscope focus. You'll find one knob on each side of the microscope arm.

## How to Place the Welding Stylus

- **If using a microscope** with the Zapp Plus, insert the Welding Stylus into the holder at the bottom of the Microscope Arm Assembly as shown in Figure 15.2.
- The tubing can be routed up and through the removable cable guide portion of the Microscope Arm Assembly if desired.
- For now, position the Welding Stylus such that only the smaller diameter portion protrudes from the holder, as shown in Figure 15.2. Then, tighten the thumb screw on the bottom of the stylus holder to hold it in place.
- Adjust the stylus holder to approximately a 45-degree angle as shown in Figure 15.2 (the stylus should be angled down).
- Fine tune the position of the Welding Stylus while looking through the microscope: Loosen the thumb screw on the bottom side of the stylus holder and slide the Welding Stylus forward and backward until the tip of the Welding Stylus is in the center of your focus. See the example in Figure 15.3.



Figure 15.2. Stylus mounting for microscope.



Figure 15.3. Only a small portion of the electrode should extrude from the holder.



Figure 16.1. Rest your hands on the table and position the workpiece close to, but not touching the electrode. Then look through the microscope.

### Microscope Tips

The Zapp Plus microscope has been designed to provide maximum visual clarity, eye protection, and ease of use. One challenge using the microscope is getting used to bringing the workpiece to the welding electrode while looking through the microscope. This is an easy challenge to overcome.

To begin, follow the suggested practices below while the welder is paused. While the welder is in paused, it will not make a weld when the workpiece touches the electrode.

Rest your hands on the table and position the workpiece close to the welding electrode before looking into the microscope.

Make sure your focus is at the tip of the electrode.

Use slow, controlled movements.

It is helpful to have your hands resting on the table and to only use your fingers to move the workpiece up to the electrode. See Figure 16.1.

Place the workpiece surface perpendicular to the point of the electrode. **As discussed in later chapters, the angle of the electrode tip relative to the workpiece surface is very important and will take practice.**

Now practice making soft contact with the workpiece to the electrode.

Once you feel comfortable, attach the alligator clip to the workpiece and touch the workpiece to the electrode. Hold still and wait for the weld to occur.

*Note: Be mindful of your energy setting: Too much power may damage the workpiece. Start low (3-4J) and work up to higher energies (8-10).*

### Microscope LCD Filter Shutter System

The Microscope LCD Filter Shutter System provides an unobstructed working view before welding and completely protects your eyes during the welding process. The Zapp Plus' internal computer verifies the Microscope LCD Filter Shutter System has been activated before allowing the weld to take place. Should the shutter not activate, the microscope lens is equipped with >UV 16 and >IR 16 for maximum eye protection.

*Warning: Avoid direct view of the welding area without protective lenses.*

### Mounting Zapp Plus Stylus in Microscope & PJ Scope:

- Install the rubber eyepiece covers onto the microscope lenses.
- Plug the included Shutter Cable into the RJ45 port on the microscope (the bottom of the microscope head). See Figure 17.1.

- Plug the other end of the Shutter Cable into the Shutter port on the back of the welder.

*Note: Connecting other RJ45 compatible devices to the Orion PJ shutter RJ45 port may damage the welder and/or the other devices.*



Figure 17.1. Bottom of microscope head.

Figure 17.2. Grey spacer head.

Product Specifications	
WELD MODES	1
PEAK POWER (J)	30 J
ENERGY (J)	1-30 J
ENERGY SETTINGS	8
WELDS/SECOND	1
WELD SPOT DIAMETER	0.5 - 2.0mm
INPUT POWER	100/230 VAC (Auto Detect)
FOOTPRINT (LXWXH)	14.60 x 17 x 9.44 cm
WEIGHT	1.9 lbs (0.86kg)
EYE PROTECTION	Auto Darkening Lens, Microscope, or Glasses



### Download the Safety Guide by scanning this QR code.

Carefully read the Safety Guide & Pulse Arc Welding Workbook to more fully understand the science behind the weld. The workbook also provides useful tips specific to different types of metals and how to use the welder in different applications. The workbook can be found together with this user manual. If the workbook is missing, call Sunstone for a complimentary replacement copy at +1 801-658-0015.





# Upgrade to an Orion™—The Professional



## Orion PJ

*The first welder ever made specifically for permanent jewelry! A professional's tool!*

1-15 Joules

0.5-1.0 mm Spot Size

1 weld per second



## Orion mPulse

*The welder for professional PJ artists or small jewelry shops. Right-sized and right-priced!*

3-30 Joules

0.75-1.5 mm Spot Size

1 weld every 2 seconds



# ional's Permanent Jewelry Welder



## Orion 100c

*When you need a bit more power, a bit more energy control, try the 100c!*

3-100 Joules

0.75-2.5 mm Spot Size

1 weld every 0.7 seconds



## Orion 100s

*The world's bestselling pulse arc welder! Most of the features and power you'll need.*

1-150 Joules

0.5-3.5 mm Spot Size

1 weld every 0.3 seconds



## Orion 200i

*For large shops who value production efficiencies—or for the master welders who deserve it all!*

0.2-200 Joules

0.1-4.5 mm Spot Size

1 weld every 0.2 seconds

*Learn More Today!*  
**Call or Text +1 801-658-0015**  
Visit [www.sunstonewelders.com](http://www.sunstonewelders.com)

  
**sunstone**<sup>®</sup>  
The Micro Welder Experts



**sunstone**<sup>®</sup>

*The Micro Welder Experts*

1693 American Way Ste 5 • Payson UT 84651 USA

Tel. +1-801-658-0015

[www.sunstonewelders.com](http://www.sunstonewelders.com)